

Railing

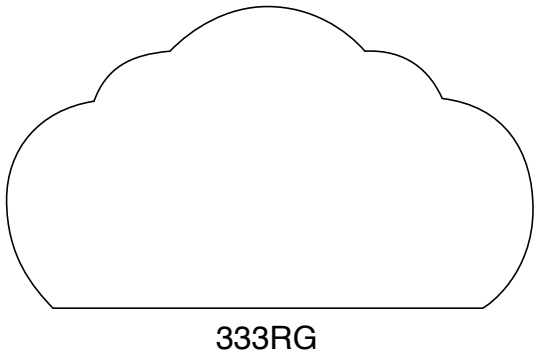

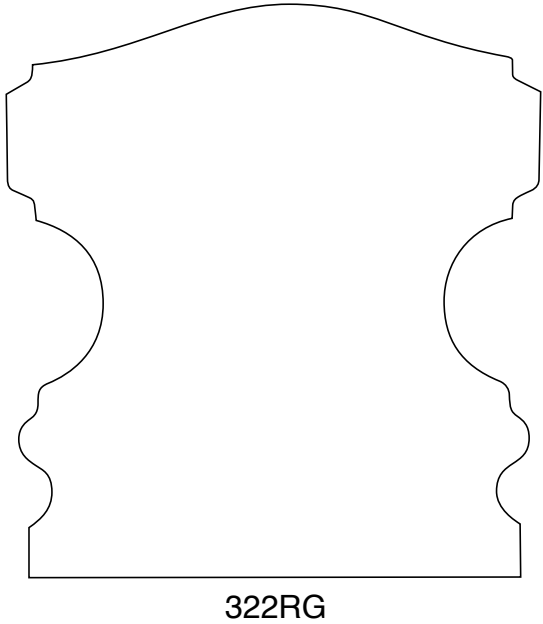

377RG

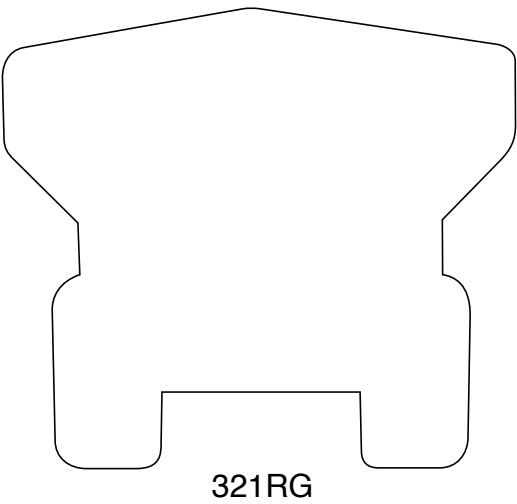
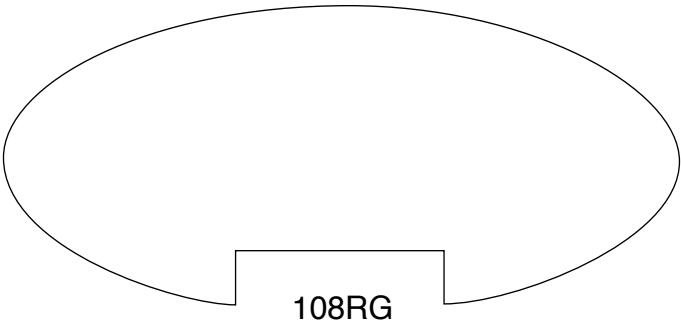
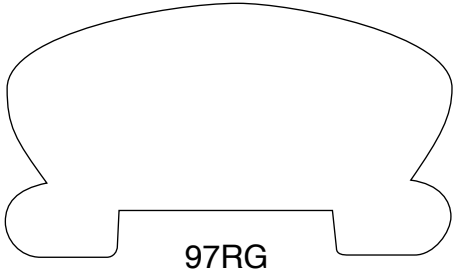
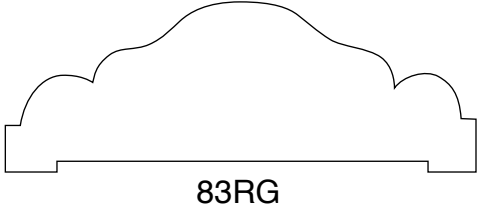
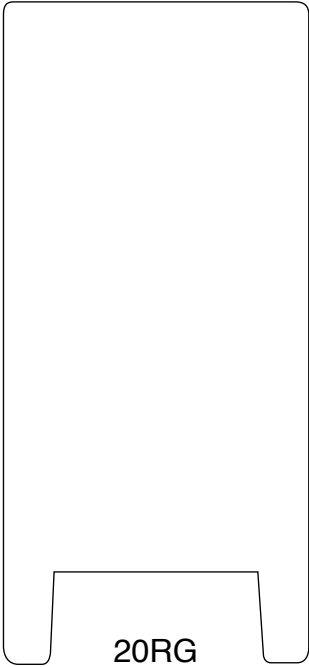
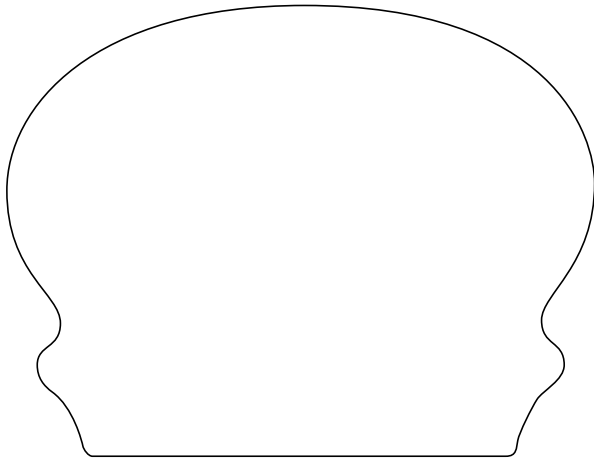
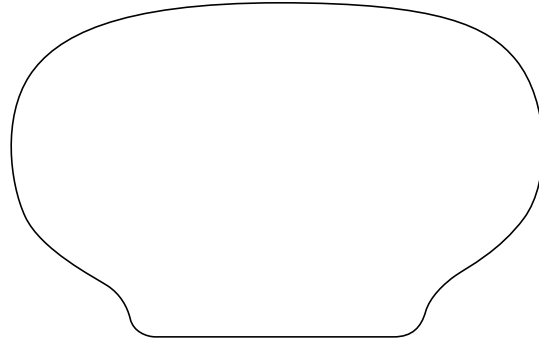

378RG

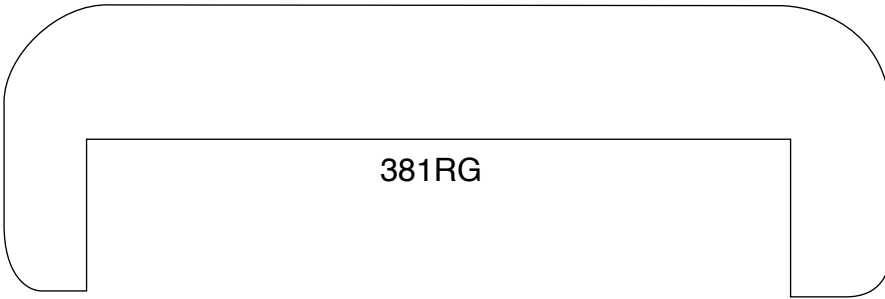

381RG

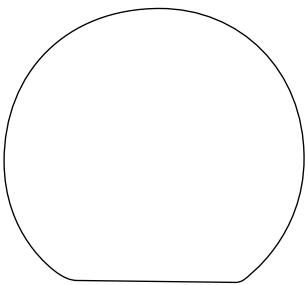

411RG

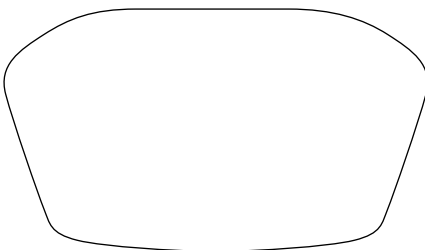

532RG

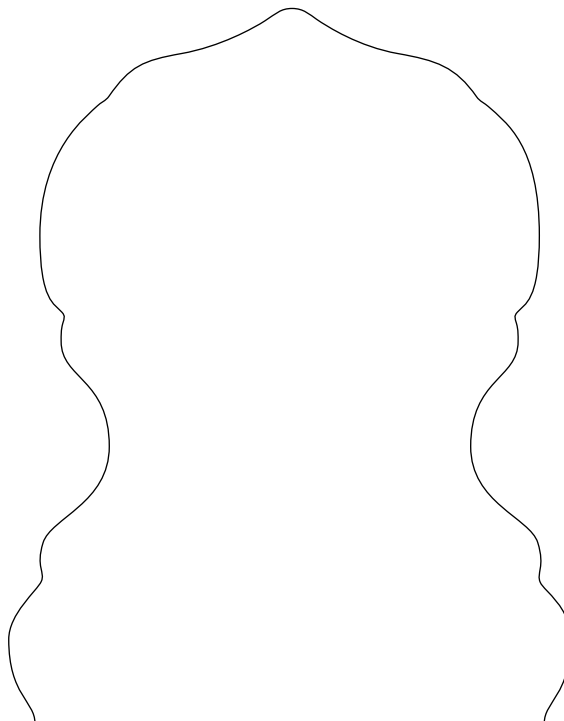

506RG

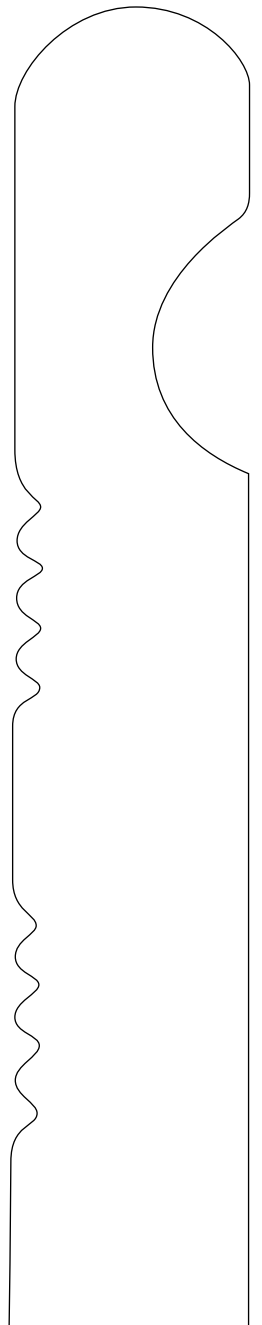

502RG

Railing

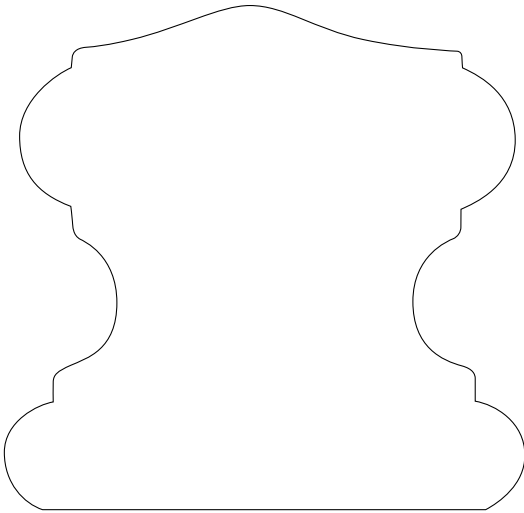

613RG

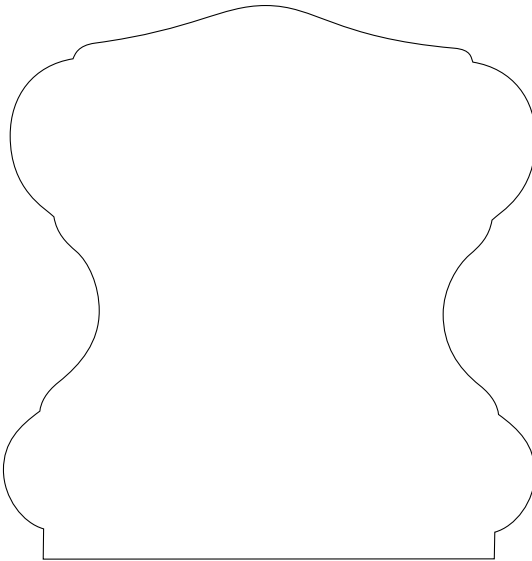

631+613RG

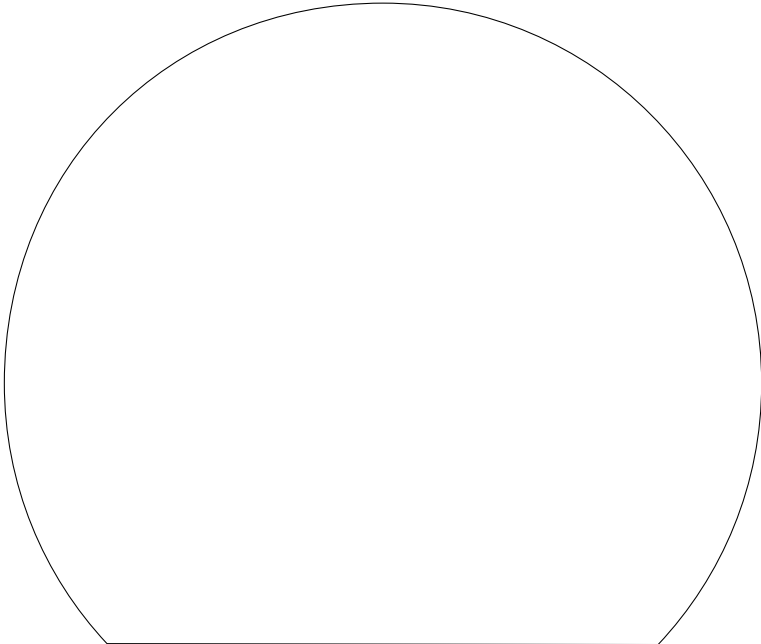

644RG